

burda Download-Schnitt

Modell 146 Burda Style 08/2016

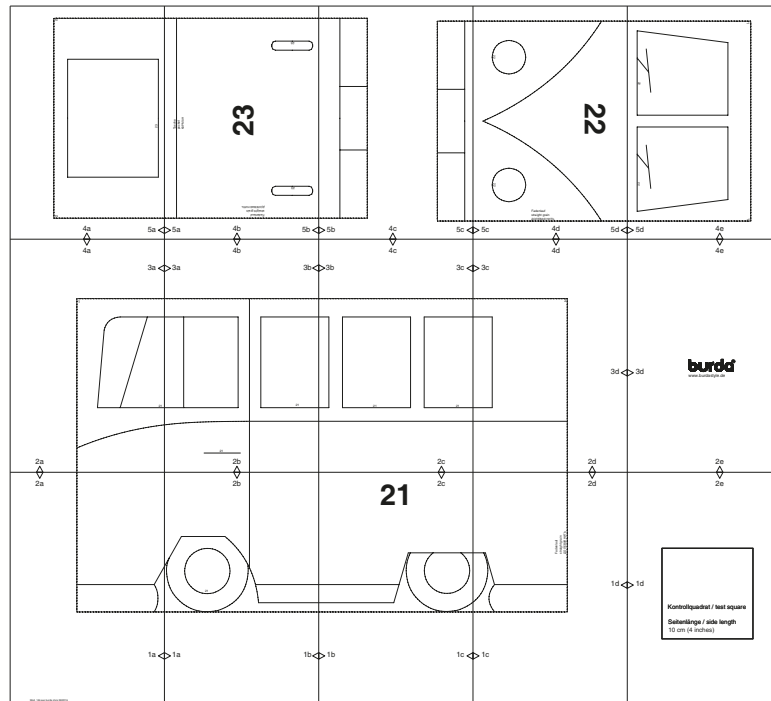

Copyright 2016 by Verlag Aenne Burda GmbH & Co. KG, Hubert-Burda Platz 2, D-77652 Offenburg
Sämtliche Modelle, Schnittteile und Zeichnungen stehen unter Urheberschutz, gewerbliches Nacharbeiten ist untersagt.
Der Verlag haftet nicht für Schäden, die durch unsachgemäße Handhabung des Schnitts, der Materialien, unsachgemäße Ausführung der Tipps und Anleitungen oder unsachgemäße Nutzung der Modelle entstehen.

2a

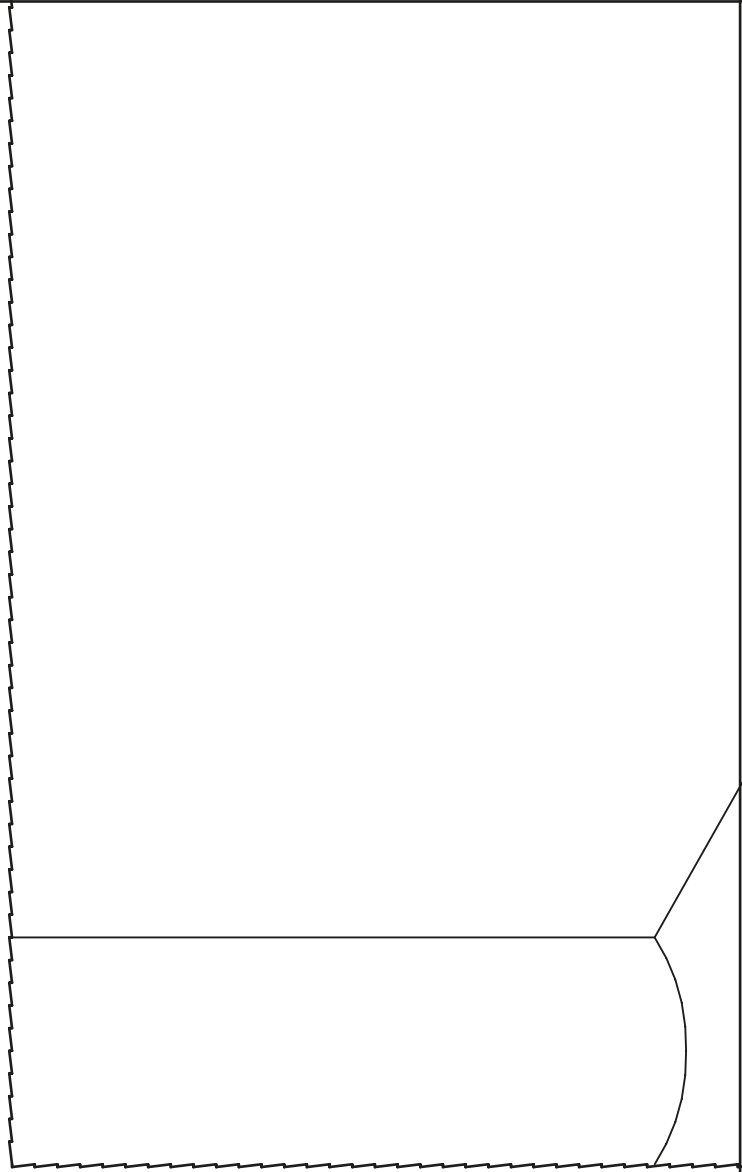

1a

2b

21

1a

1b

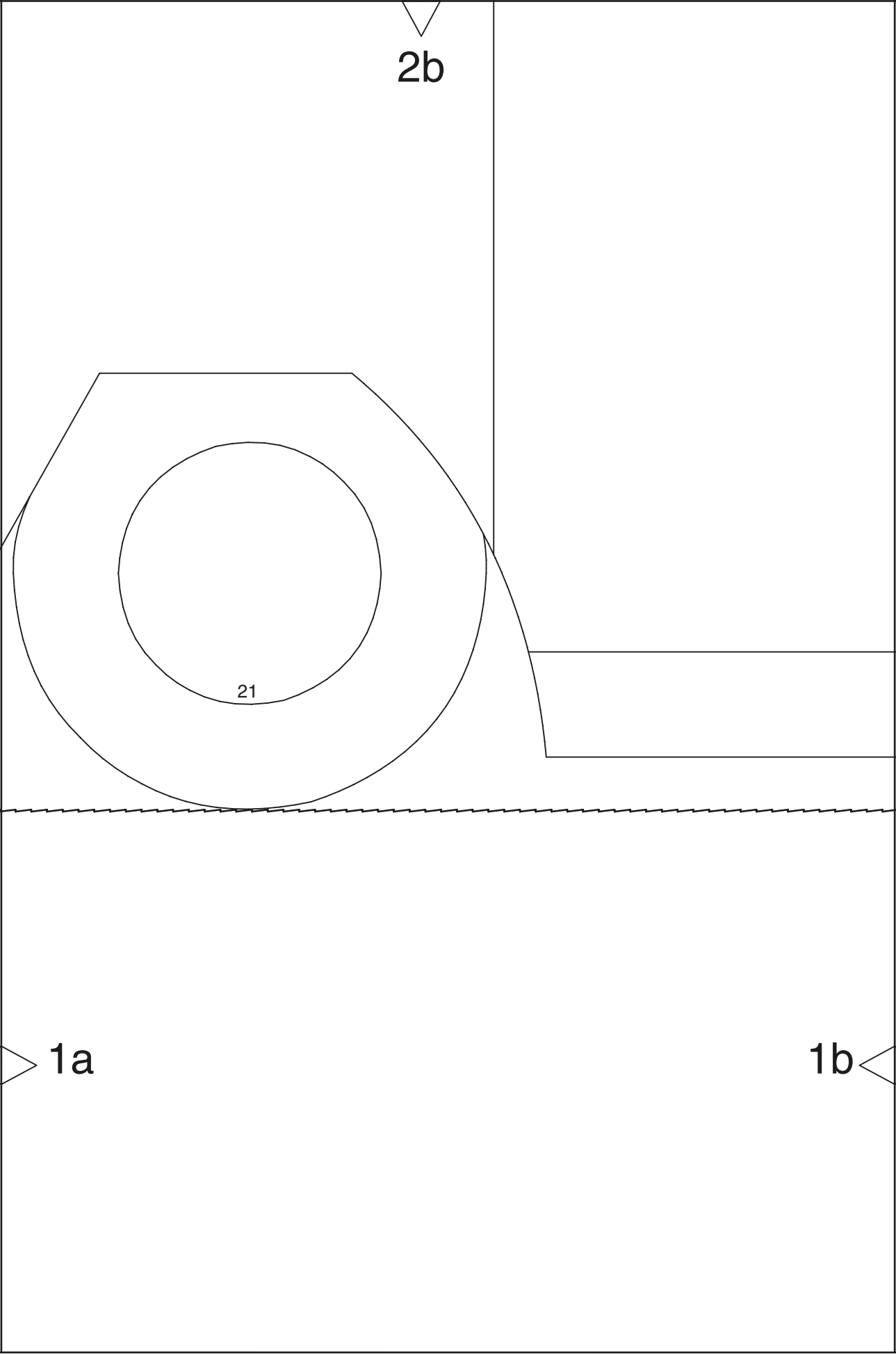

21

2c

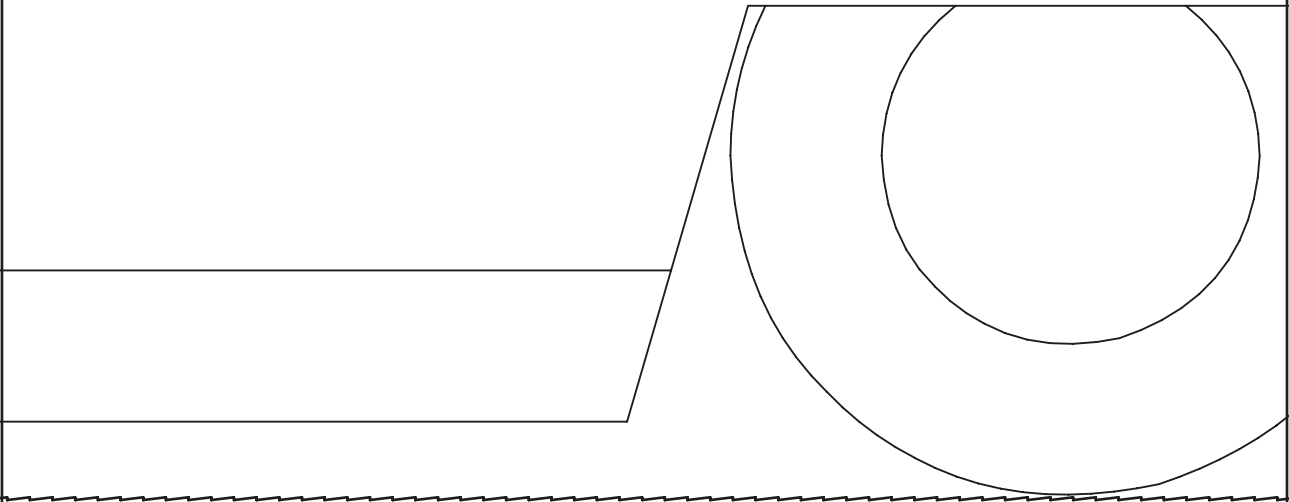

1b

1c

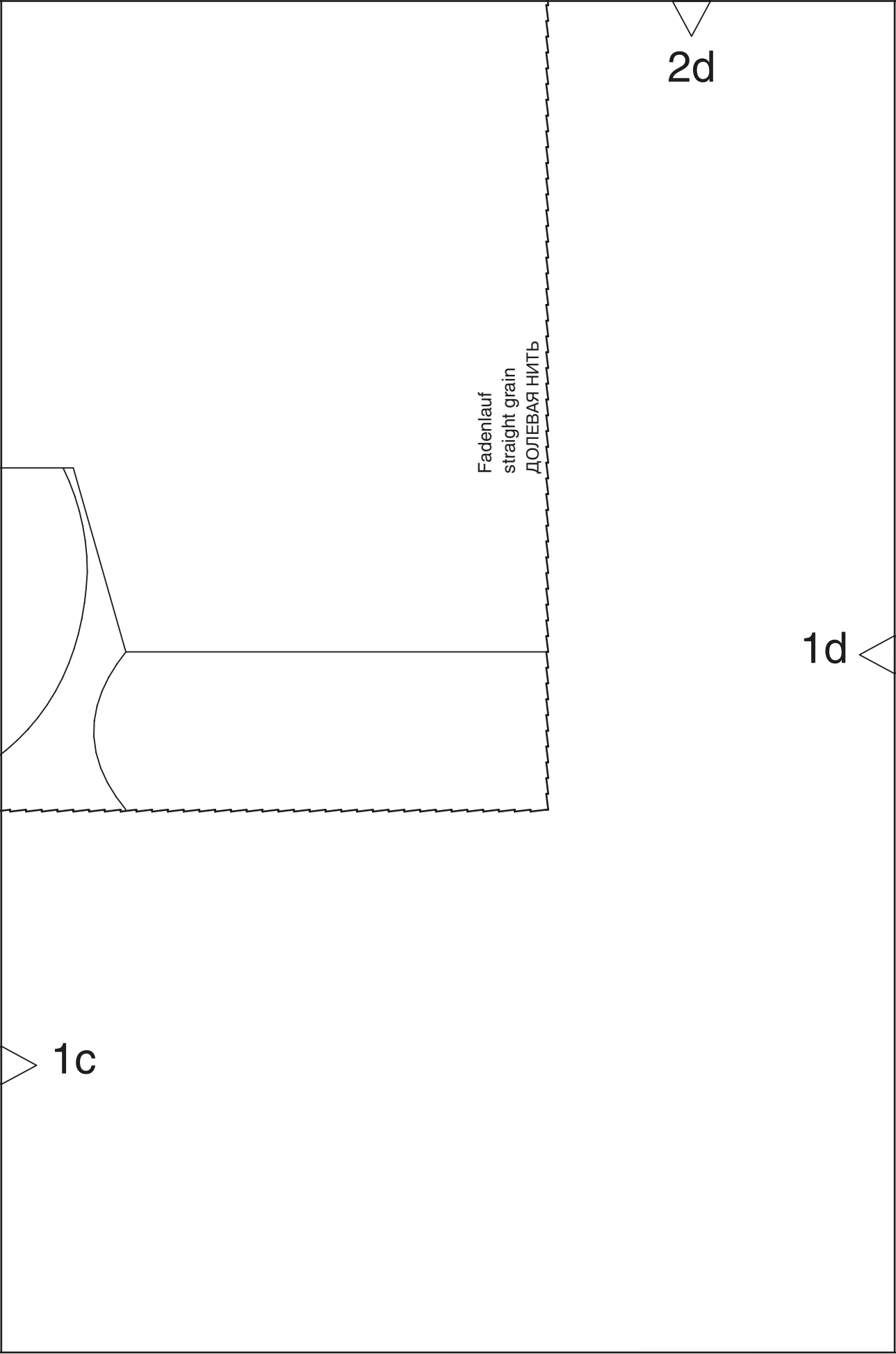

2d

Fadenlauf
straight grain
ДОЛБАВАЯ НИТЬ

1d

1c

2e

1d

Kontrollquadrat / test square

Seitenlänge / side length
10 cm (4 inches)

4a

3a

1

21

2a

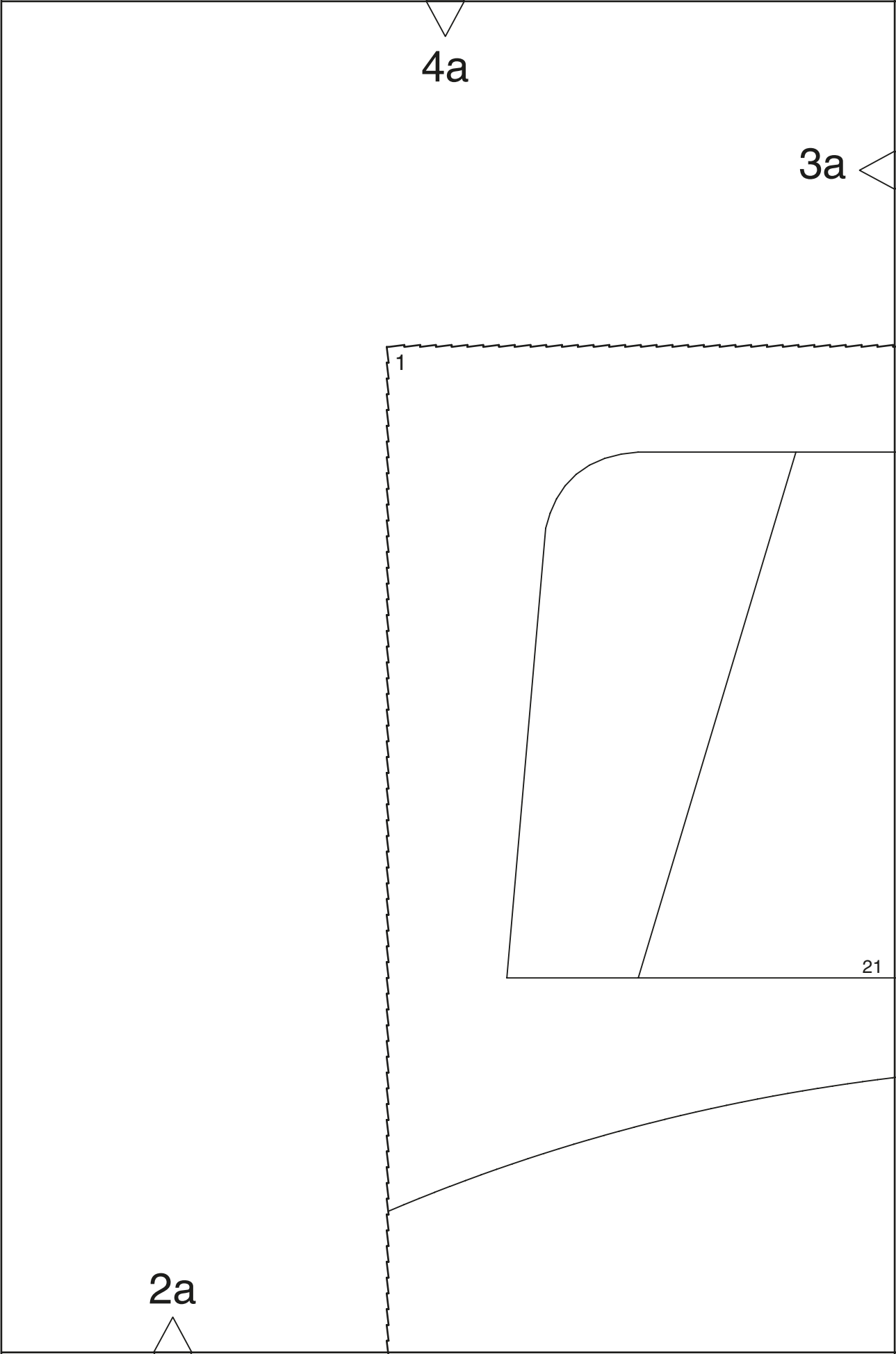

4b

3a

3b

21

21

2b

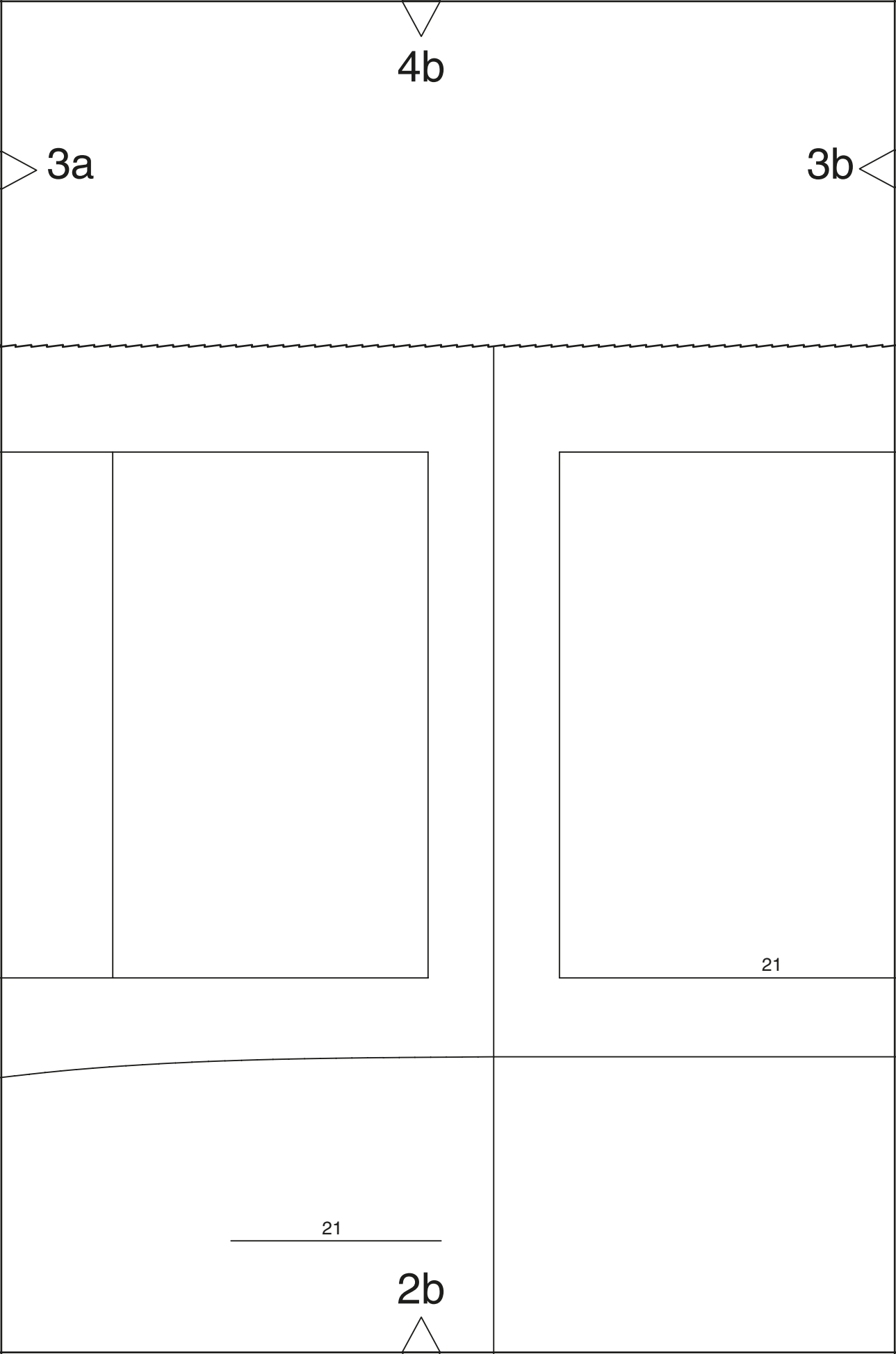

A diagram showing a rectangular layout. At the top center is a downward-pointing triangle with the label '4c' below it. On the left side, a rightward-pointing triangle is labeled '3b'. On the right side, a leftward-pointing triangle is labeled '3c'. A horizontal dashed line runs across the upper portion of the diagram. Below this line are three rectangular blocks. The leftmost block is a narrow vertical rectangle. The middle and right blocks are larger and wider than the left one. Each of these two larger blocks has the label '21' at its bottom center. At the bottom center of the entire diagram is an upward-pointing triangle with the label '2c' above it.

4c

3b

3c

21

21

2c

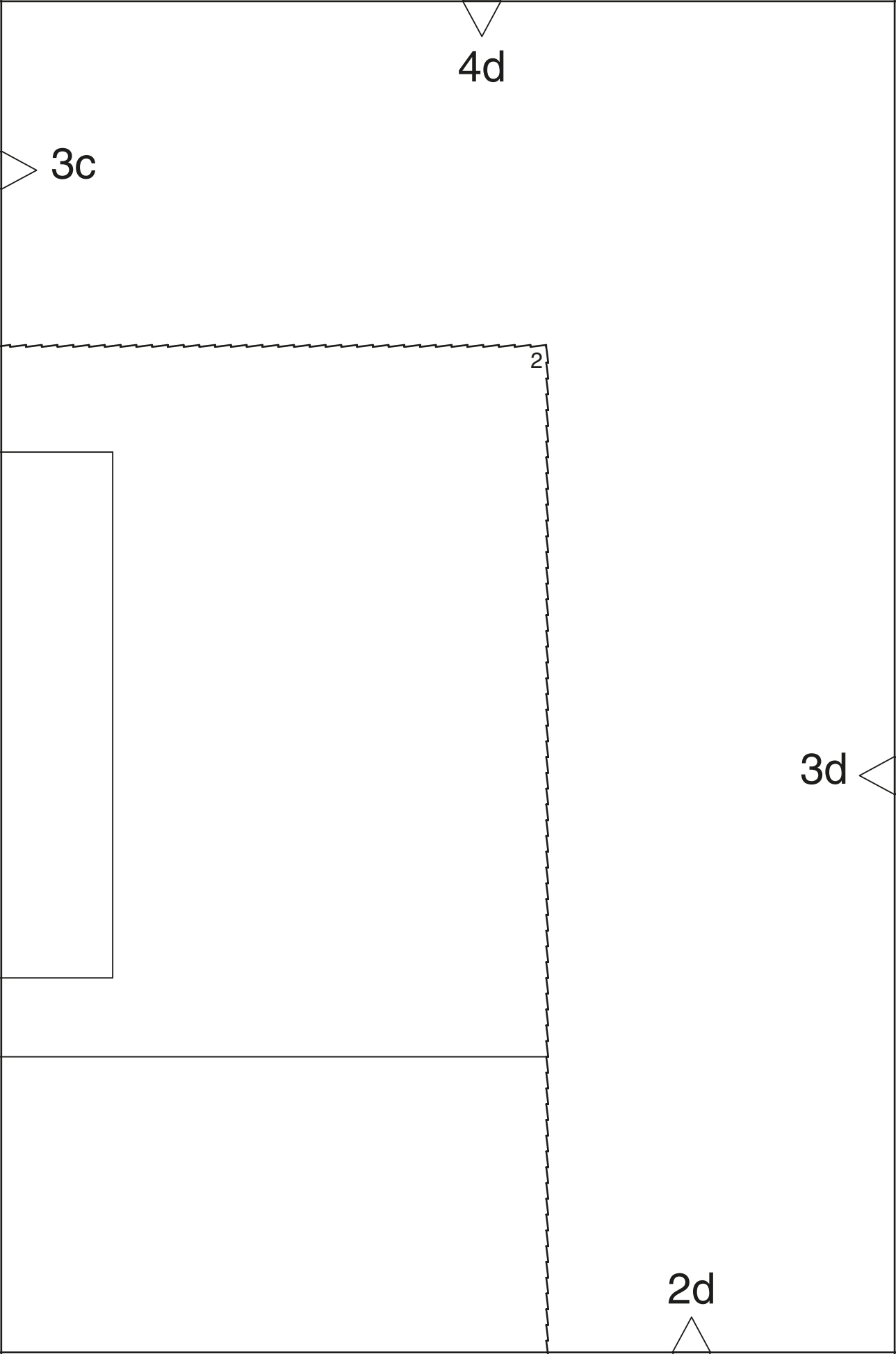

4e

3d

burda[®]
www.burdastyle.de

2e

2

2

23

4a

5a

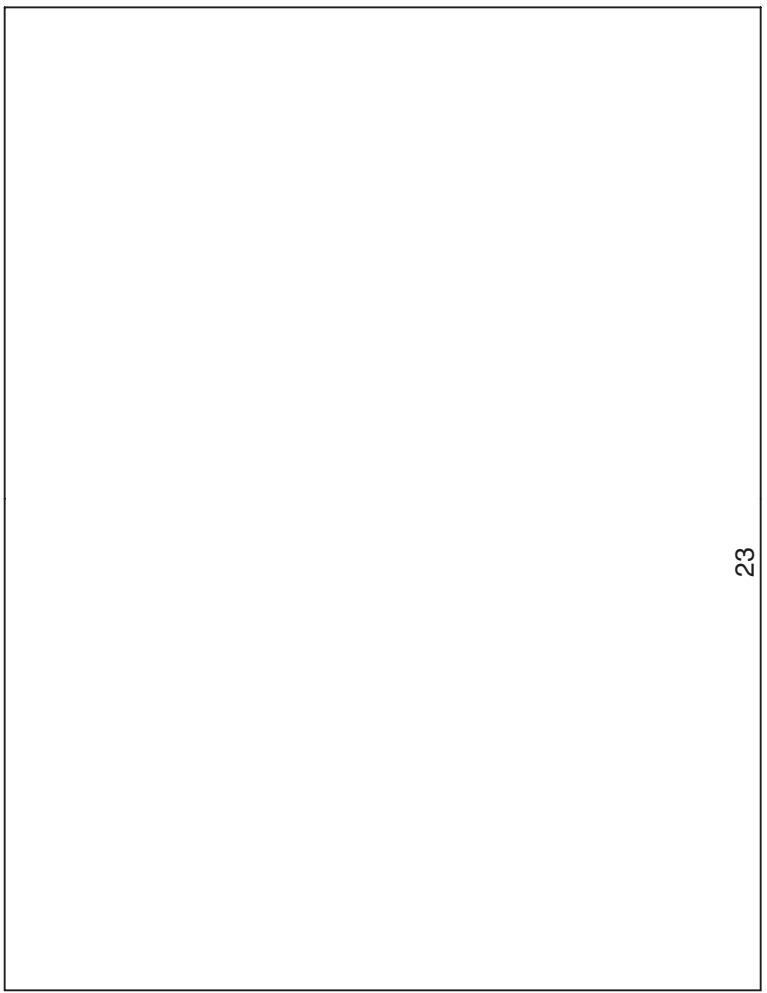

Tasche
pocket
КАРМАН

23

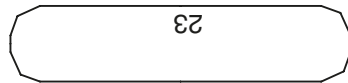
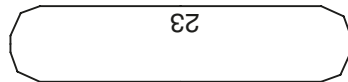

Fadenlauf
straight grain
ДОЛБВАЯ НИТЬ

5a

4b

5b

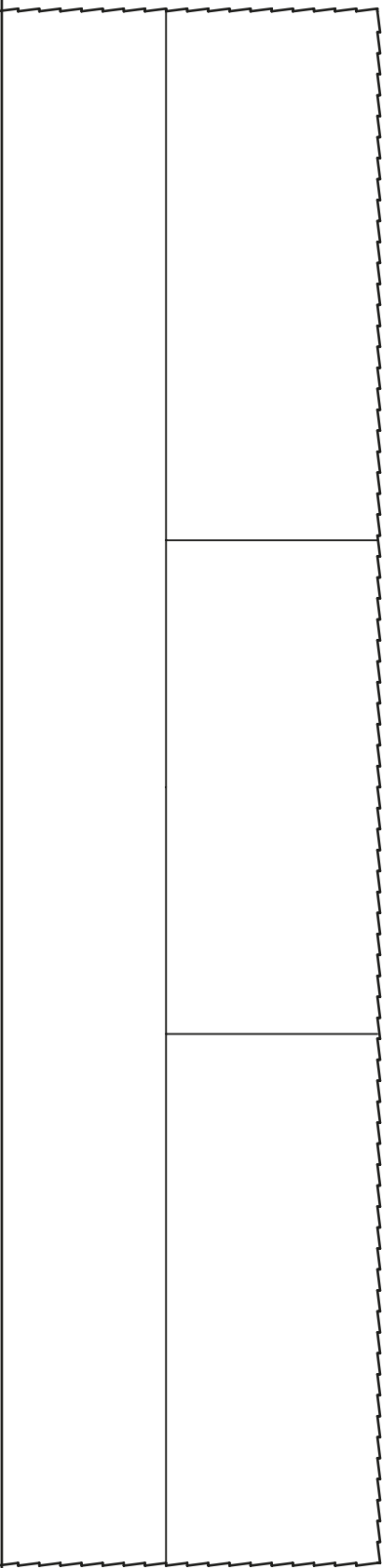

5b

4c

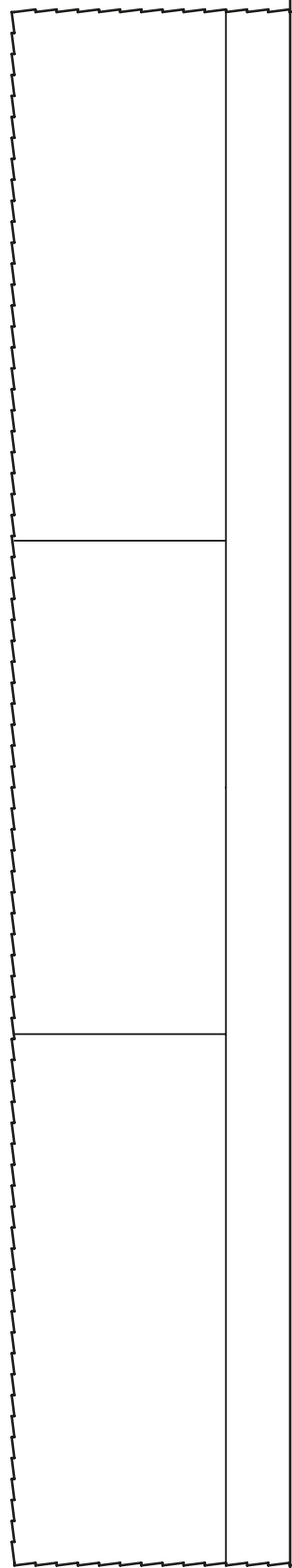

5c

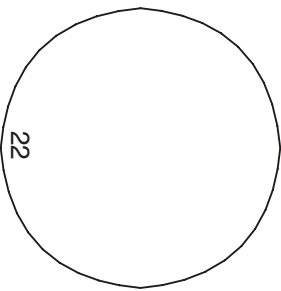
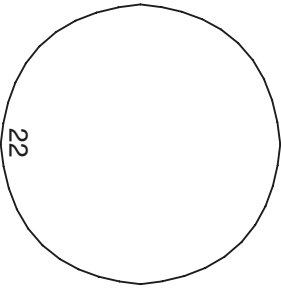

22

Fadenlauf
straight grain
ДОЛЕВАЯ НИТЬ

5c

4d

5d

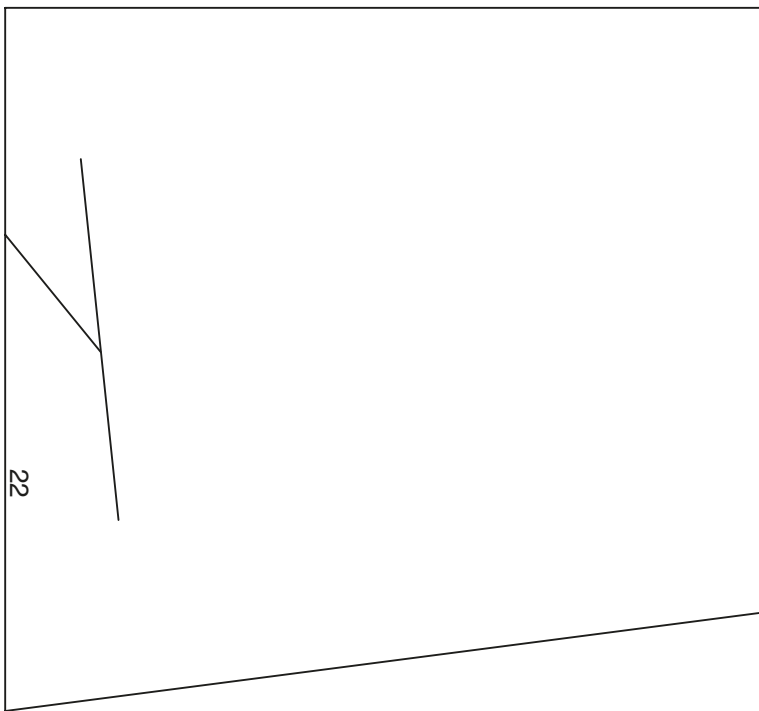
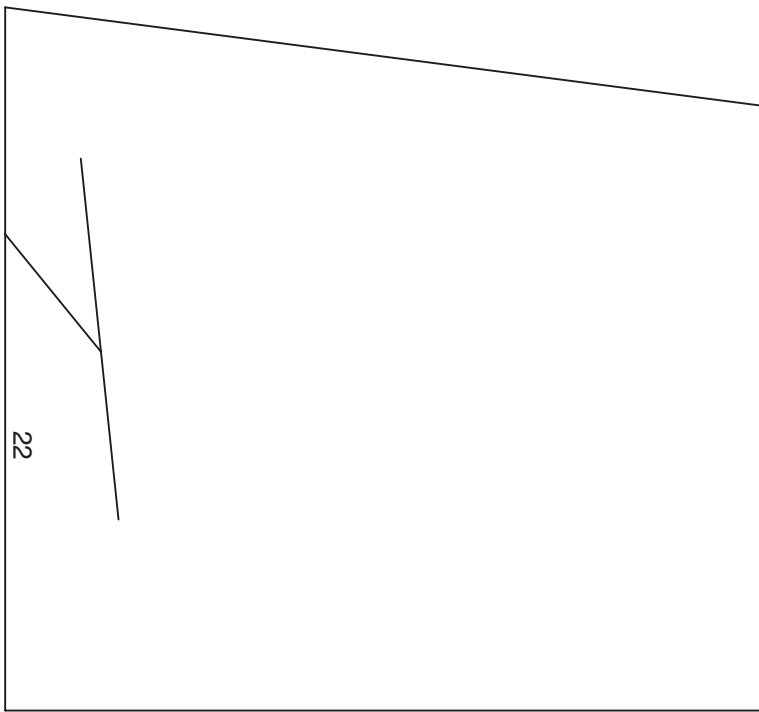

5d

4e